

SWISSDIS



Swissdis AG
Grasweg 7
CH-4911 Schwarzhäusern

Tel.: +41 62 919 44 00
Fax: +41 62 919 44 01
info@swissdis.ch
www.swissdis.ch



SPECIFICATIONS

US0605RG LED Chip 0605 Red Green

Version April 2015

Unilite Opto Technology

U-S0605RG

■ Description

The SMD type U-S0605 RG 2 chips LED, with its light weight and smaller than lead frame type components, enables smaller board size, higher packing density, reduced storage space and miniature applications.



- Dice Material : InGaN: Green and AlInGaP: Red,
- Light Color : Red, Green
- Lens Color : Water Clear

■ Features

- 2 chips package
- Compatible with automatic placement equipment
- Compatible with reflow soldering process
- Long operating life
- Low forward voltage operated
- Instant light
- Pb -free/ RoHS compliant

■ Applications

- Information boards
- Automotive Interior Lighting
- Indoor and outdoor display
- Indicator
- Backlighting
- General applications

Unilite Opto Technology

U-S0605RG

Outline Dimensions (mm)

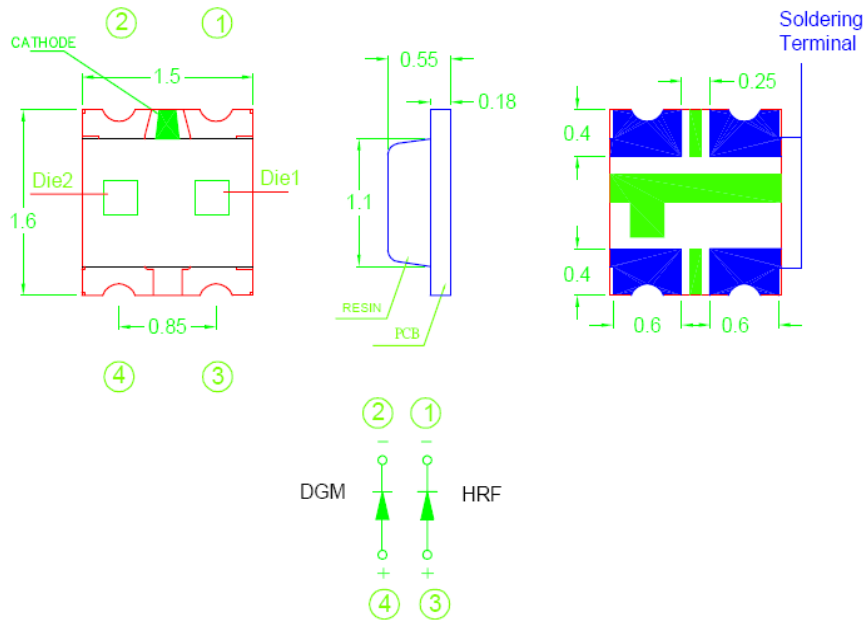

Tolerance : ± 0.1 mm

Recommended Soldering Pad Design

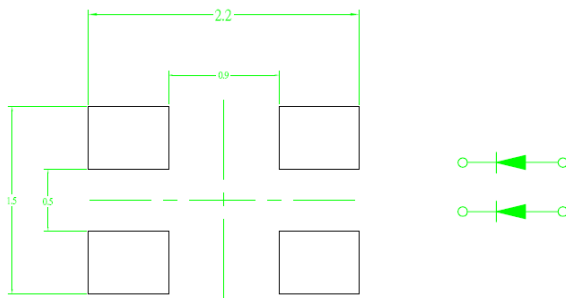

Note: The tolerance unless mentioned is ± 0.1 mm, Angel ± 0.5 . Unit=mm

Part Numbering System

U - S 0 6 0 5 R G

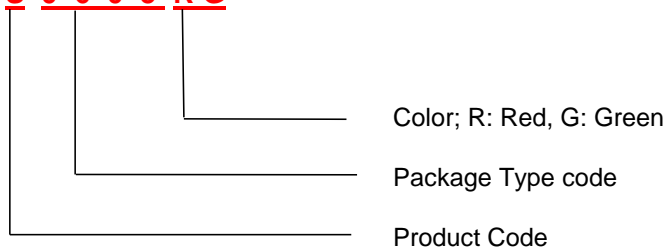

Unilite Opto Technology

U-S0605RG

■ Absolute Maximum Ratings at Ta = 25 °C

PARAMETER	symbol	MAX.	UNIT
Power Dissipation *	PD	Red 72	mW
		Green 80	
Continuous Forward Current *	IF	Red 30	mA
		Green 20	
Peak Forward Current (1/10 Duty Cycle , 0.1ms Pulse Width) *	IFP	Red 90	mA
		Green 100	
Reverse Voltage	IR	Red 10	μA
		Green 50	
Electrostatic Discharge	ESD	Red 2000	V
		Green 150	
Operating Temperature Range	Topr	-40 to + 85	°C
Storage Temperature Range	Tstg	-40 to + 90	°C
Reflow Soldering Condition	Tsld	265 °C for 5 sec.	

■ Electro-Optical Characteristics Red , Ta = 25°C, IF=20mA

PARAMETER	SYMBOL	VALUES			UNIT
		MIN.	TYP.	MAX.	
Luminous Intensity	IV	32		200	mcd
Forward Voltage	Vf	1.5		2.4	V
View angle	2θ 1/2		130		Deg
Dominant Wavelength	λd		630	642	nm
Reverse Current, VR= 5V	IR			10	μA

■ Electro-Optical Characteristics Green , Ta = 25°C, IF=20mA

PARAMETER	SYMBOL	VALUES			UNIT
		MIN.	TYP.	MAX.	
Luminous Intensity	IV	200		800	mcd
Forward Voltage	Vf	2.8		3.5	V
View angle	2θ 1/2		130		Deg
Dominant Wavelength	λd	518	525		nm
Reverse Current, VR= 5V	IR			50	μA

Unilite Opto Technology

U-S0605RG

■ Bin Code

Unit: mcd@20mA

Bin Code		IV	
		Min	Max
Red	R1	32	50
	R2	50	80
	R3	80	125
	R4	125	200

Bin Code		IV	
		Min	Max
Green	G1	200	320
	G2	320	500
	G3	500	800
	G4	800	1250

Unilite Opto Technology

U-S0605RG

■ Typical Electro-Optical Characteristics Curve--RED

Fig.1 Forward current vs. Forward Voltage

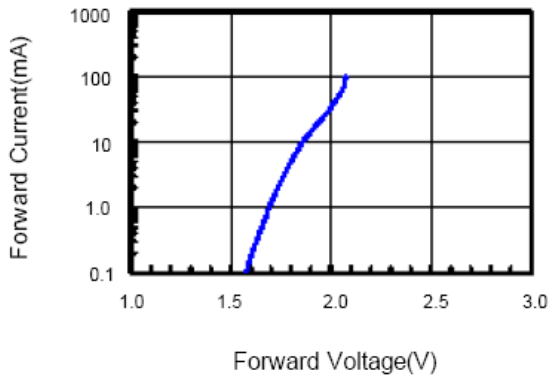

Fig.2 Relative Intensity vs. Forward Current

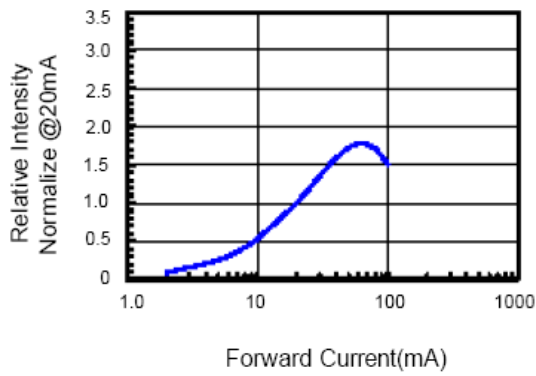

Fig.3 Forward Voltage vs. Temperature

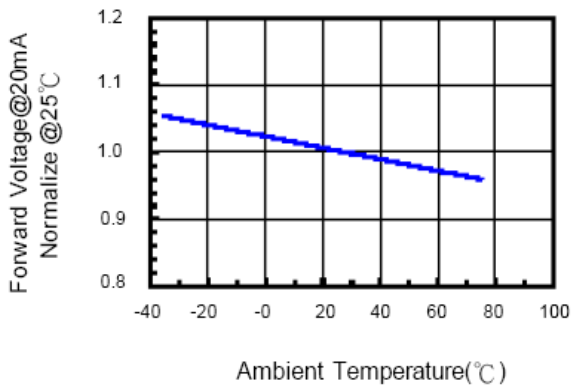

Fig.4 Relative Intensity vs. Temperature

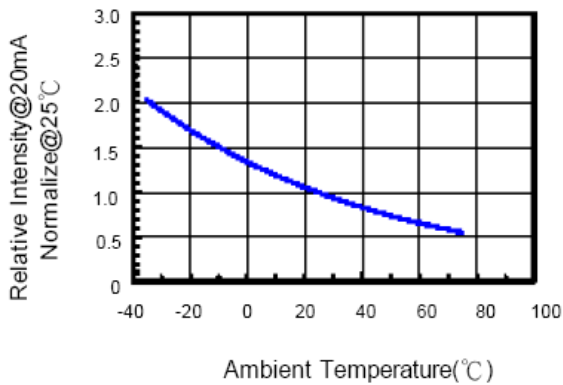

Fig.5 Relative Intensity vs. Wavelength

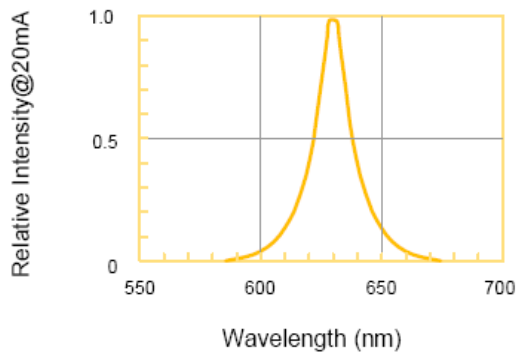
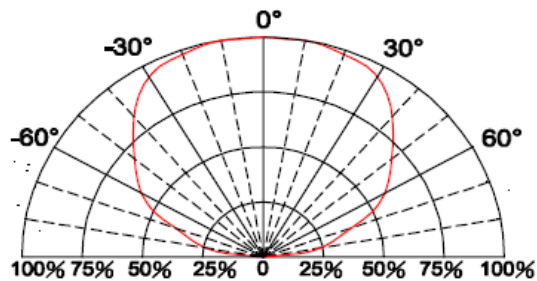

Fig.6 Directive Radiation



Unilite Opto Technology

U-S0605RG

■ Typical Electro-Optical Characteristics Curve--Green

Fig.1 Forward current vs. Forward Voltage

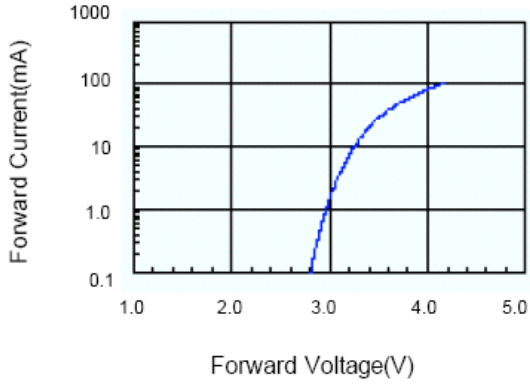

Fig.2 Relative Intensity vs. Forward Current

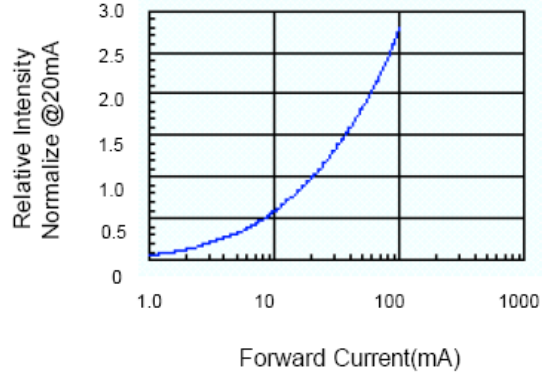

Fig.3 Forward Voltage vs. Temperature

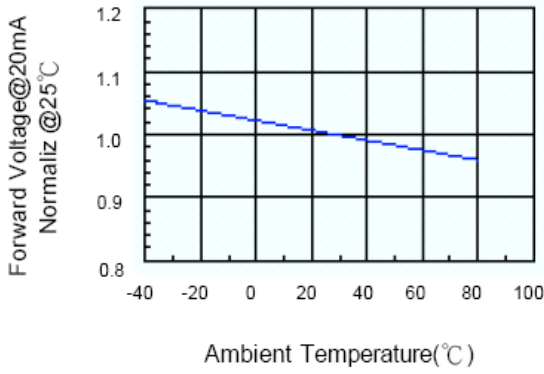

Fig.4 Relative Intensity vs. Temperature

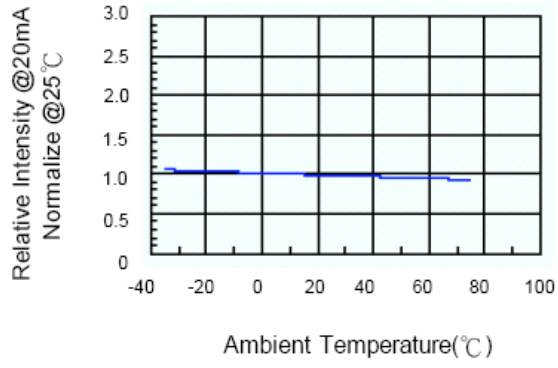

Fig.5 Relative Intensity vs. Wavelength

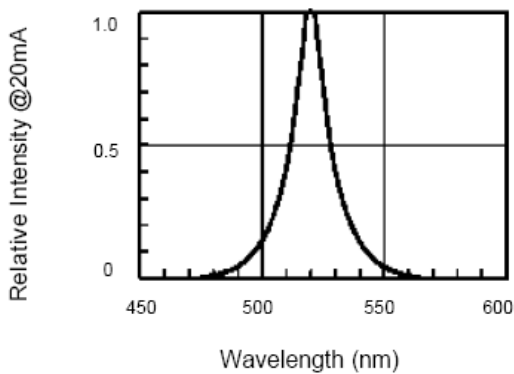
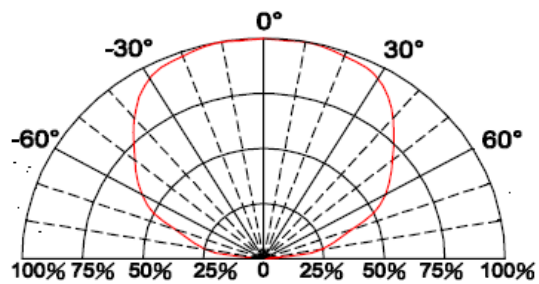

Fig.6 Directive Radiation



Unilite Opto Technology

U-S0605RG

Carrier Type Dimensions

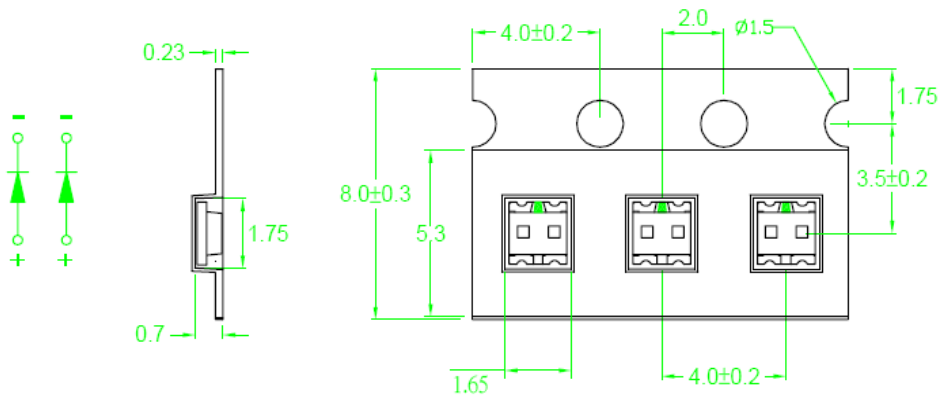

Reel Dimensions

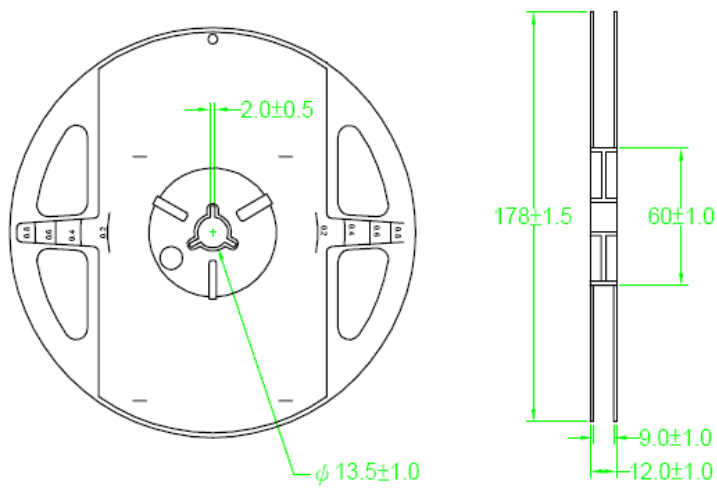

Unilite Opto Technology

U-S0605RG

■ Reliability Test Items and Conditions

(1) TEST ITEMS AND RESULTS

Test Item	Standard Test Method	Test Conditions	Note	Number of Damaged
Thermal Shock	MIL-ST-	-40°C ~ 105°C 10min. 10min.	100 cycles	0/60
	MIL-ST-			
	MIL-ST-			
Temperature Cycle	MIL-ST-	105°C ~ 25°C ~ -55°C ~ 25°C 30min. 5min. 30min. 5min.	10 cycles	0/60
	MIL-ST-			
	MIL-ST-			
	JIS C 7021:A-4			
High Temperature Storage	MIL-STD-	Ta=105°C +/- 5°C	1000 hrs.	0/60
	JIS C 7021:B-10			
Low Temperature Storage	JIS C 7021:B-12	Ta=-40°C +/- 5°C	1000 hrs.	0/60
Steady State Operating Life	MIL-STD-	Ta=25°C, I _F =20mA, DC	1000 hrs.	0/60
	MIL-STD-			
	JIS C 7021:B-1			
High Temperature & High Humidity Storage Test	MIL-ST-202F:103B JIS C 7021:B-11	Ta=65°C +/- 5°C, RH=90-95%,	1000 hrs.	0/60
Solerability Test	MIL-ST-	T. Sol:235°C +/- 5°C	10 cycles	0/60
	MIL-STD-	Immersion Time 2 +/- 0.5sec		
	MIL-STD-	Coverage ≥ 95% of the dipped		
	IEC 68 Part 2-20			
	JIS C 7021:A-2			
IR Reflow	MIL-STD-750D:2031.2	T=260C Max, 10 sec Max,		
	J-STD-020	Time= 6min		

Unilite Opto Technology

U-S0605RG

■ Cautions

(1) Moisture Proof Package

- A) The moisture proof package, a plastic bag with a zipper, is used to keep moisture to a minimum in the package.
- B) A package of a moisture absorbent material (silica gel) is also inserted into the plastic moisture proof bag and the silica gel changes its color from blue to pink as it absorbs moisture.
- C) The absorbed moisture in the SMT package may vaporize and expand during soldering. This may cause exfoliation of the contacts and damage to the optical characteristics of the LEDs.

(2) Storage Conditions

- A) Before opening the package :
The LEDs should be kept at 30°C or less and 45~60% RH or less and should be used within a year. When storing the LEDs, moisture proof package with absorbent material (silica gel) is recommended.
- B) After opening the package :
The LEDs should be kept at 30°C or less and 55% RH or less and should be soldered within 168 hours (7days) after opening the package. The unused LEDs should be stored in moisture proof packages.
- C) It's also recommended to return the LEDs to the original moisture proof bag and to reseal the moisture proof bag again.
- D) If the moisture absorbent material (silica gel) has faded away or the SMD LEDs have exceeded the storage time, baking treatment (more than 24 hours at 65+/-5°C) should be performed before soldering.

(3) Heat Generation

- A) The thermal design of the end product is very important. It is necessary to avoid intense heat generation and operate within the maximum ratings given in this specification.
- B) The operating current should be decided after considering the ambient maximum temperature of LEDs.

(4) Cleaning

- A) Isopropyl alcohol is recommended to be used as a solvent for cleaning the LEDs.
- B) Before cleaning, a pre-test should be done to confirm whether any damage to the LEDs will occur.

Unilite Opto Technology

U-S0605RG

(5) Soldering

Reflow Soldering (recommended) :

- A) To prevent from cracking, please bake (65°C , 24hrs) before soldering.
- B) When soldering, do not load stress on the LEDs during heating.
- C) Never take next process until the component is cooled down to room temperature after reflow.
- D) After soldering, do not warp the circuit board.
- E) The recommended reflow soldering profile (measuring on the surface of the LED resin) is the following:

(a) Lead-Free Solder

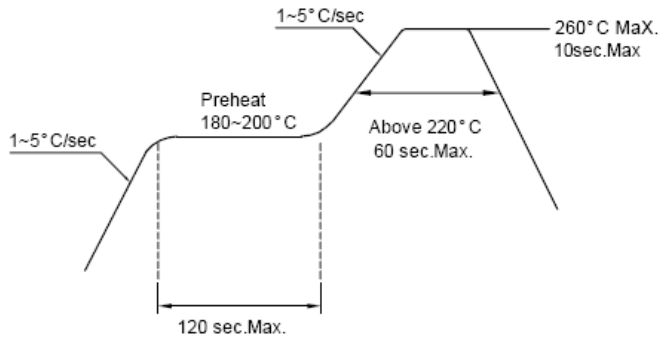

(b) Lead Solder

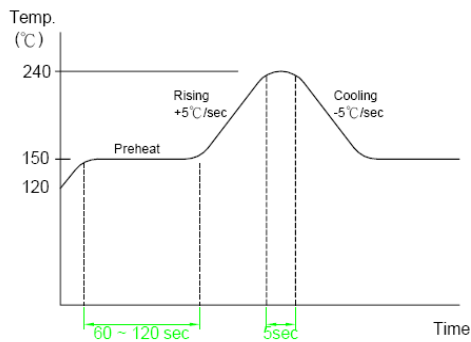

Manual Soldering (not recommended) :

- A) To prevent from cracking, please bake (65°C , 24hrs) before soldering.
- B) Temperature at tip of iron: 250°C Max. (25W).
- C) It's banned to load any stress on the resin during soldering.
- D) Soldering time: 3 sec. Max.(one time only).

Unilite Opto Technology

U-S0605RG

- (6) ESD (electrostatic discharge) protection (base on machine mode)
- A) The product is Gallium Nitride (GaN) based light emitting diode (LED) and is extremely sensitive to ESD. Users are strongly recommended to take necessary meter to test the static electricity and avoid ESD when handling this product.
 - B) Proper grounding of machines (via $1M\Omega$), using static dissipative mats, containers, working uniforms and shoes are considered to be effective against ESD.
 - C) An ionizer is recommended in the facility or environment where ESD may be generated easily, and soldering iron with a grounded tip is also recommended.
 - D) When inspecting the final products in which LEDs are assembled, it is recommended to check whether the assembled LEDs are damaged by ESD or not. It is simple to find damaged LEDs by light-on or VF test at lower current (below 1mA is recommended).
 - E) ESD damaged LEDs will show some unusual characteristics such as the remarkable increasing of leak current, the decreasing of forward voltage, or the LEDs do not light on at the low current.
- (7) Other
- A) Care must be taken to ensure that the reverse voltage will not exceed the absolute maximum rating when using the LEDs with matrix drive.
 - B) The LED light output is strong enough to injure human eyes. Precaution must be taken to prevent looking directly at the LEDs with unaided eyes for more than a few seconds.
 - C) The LEDs described here are intended to be used for ordinary electronic equipment, please consult Unilite Opto in advance for information on applications.
 - D) Installing a protection device in the LED driving circuit to avoid surge current exceeding the max rating during on/off switching.
 - E) The appearance and specifications of the product may be modified for improvement without notice.
 - F) Please use the product within 168 hours after opening the seal and keep under $30\text{ }^{\circ}\text{C}$ and 70% humidity.
 - G) Unilite Opto Technology will not be responsible for any claim for damage if the user use the product without following the caution or instruction of the specification.