

**SWISSDIS**



Swissdis AG  
Grasweg 7  
CH-4911 Schwarzhäusern

Tel.: +41 62 919 44 00  
Fax: +41 62 919 44 01  
[info@swissdis.ch](mailto:info@swissdis.ch)  
[www.swissdis.ch](http://www.swissdis.ch)



# SPECIFICATIONS

Multilayer Chip Inductor

## CL-S Serie

Version October 2021

## Multilayer Chip Inductor

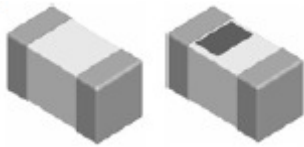

### Features

- Monolithic structure for high reliability
- High self-resonant frequency
- Excellent solderability and high heat resistance

### Applications

- RF circuit in telecommunication and other equipments

### Construction

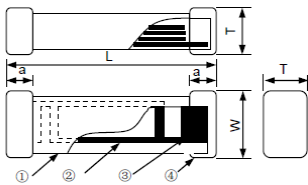

① Ceramic Material	③ Pull Out Electrode
② Internal Electrode	④ End-termination

### Dimensions

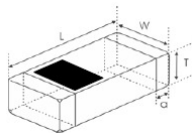

Figure1

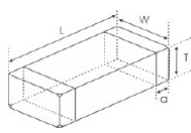

Figure2

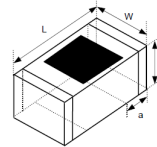

Figure3

#### Standard

Unit: mm

Type	Size (Inch)	Figure	L	W	T	a
CL02-S (<12nH)	0402	1	1.00±0.15	0.50±0.15	0.50±0.15	0.25±0.10
CL02-S (≥12nH)	0402	1&2	1.00±0.15	0.50±0.15	0.50±0.15	0.25±0.10
CL03-S (<560nH)	0603	2	1.60±0.20	0.80±0.20	0.80±0.20	0.30±0.20
CL03-S (≥560nH)	0603	2	1.65±0.20	0.80±0.20	0.80±0.20	0.30±0.20

#### High Q

Unit: mm

Type	Size (Inch)	Figure	L	W	T	a
CL01-S	0201	1	0.60±0.05	0.30±0.05	0.30±0.05	0.15±0.05
CL02-S	0402	3	1.00±0.15	0.50±0.15	0.50±0.15	0.25±0.10

#### High Frequency

Unit: mm

Type	Size (Inch)	Figure	L	W	T	a
CL02-S	0402	2	1.00±0.15	0.50±0.15	0.50±0.15	0.25±0.10
CL03-S	0603	2	1.60±0.15	0.80±0.15	0.80±0.15	0.30±0.20

### Part Numbering

CL	02	J	T		1N0	-S
Product Type	Dimensions	Inductance Tolerance	Packaging Code	Appearance	Inductance	
	01: 0201 02: 0402 03: 0603	B: ±0.1nH C: ±0.2nH S: ±0.3nH G: ±2% H: ±3% J: ±5% K: ±10%	T: Taping Reel	: Standard Q: High Q F: High Frequency	1N0: 1.0nH 39N: 39nH R10: 100nH	

**Standard Electrical Specifications**

CL02-S Multilayer Chip Inductors / Standard Type

Inductance (nH)	Tolerance	Quality Factor /min.	Test Freq. (MHz)	Test Voltage (mV)	SRF (GHz) Min.	RDC (Ω) Max.	Rate Current (mA) Max.
1.0	±0.1nH, ±0.2nH, ±0.3nH	8	100	50	10.00	0.06	1000
1.1	±0.1nH, ±0.2nH, ±0.3nH	8	100	50	10.00	0.07	1000
1.2	±0.1nH, ±0.2nH, ±0.3nH	8	100	50	10.00	0.07	1000
1.3	±0.1nH, ±0.2nH, ±0.3nH	8	100	50	10.00	0.07	1000
1.5	±0.1nH, ±0.2nH, ±0.3nH	8	100	50	6.00	0.08	1000
1.6	±0.1nH, ±0.2nH, ±0.3nH	8	100	50	6.00	0.08	1000
1.8	±0.1nH, ±0.2nH, ±0.3nH	8	100	50	6.00	0.08	900
2.0	±0.1nH, ±0.2nH, ±0.3nH	8	100	50	6.00	0.09	900
2.2	±0.1nH, ±0.2nH, ±0.3nH	8	100	50	6.00	0.09	900
2.4	±0.1nH, ±0.2nH, ±0.3nH	8	100	50	6.00	0.10	800
2.7	±0.1nH, ±0.2nH, ±0.3nH	8	100	50	6.00	0.12	800
3.0	±0.1nH, ±0.2nH, ±0.3nH	8	100	50	6.00	0.12	800
3.3	±0.1nH, ±0.2nH, ±0.3nH	8	100	50	6.00	0.13	800
3.6	±0.1nH, ±0.2nH, ±0.3nH	8	100	50	4.00	0.15	700
3.9	±0.1nH, ±0.2nH, ±0.3nH	8	100	50	4.00	0.16	700
4.3	±0.1nH, ±0.2nH, ±0.3nH	8	100	50	4.00	0.16	700
4.7	±0.1nH, ±0.2nH, ±0.3nH	8	100	50	4.00	0.16	700
5.1	±0.1nH, ±0.2nH, ±0.3nH	8	100	50	4.00	0.16	600
5.6	±0.1nH, ±0.2nH, ±0.3nH	8	100	50	4.00	0.20	600
6.2	±0.1nH, ±0.2nH, ±0.3nH	8	100	50	3.90	0.20	600
6.8	±3%, ±5%	8	100	50	3.90	0.20	600
7.5	±3%, ±5%	8	100	50	3.70	0.24	500
8.2	±3%, ±5%	8	100	50	3.60	0.24	500
9.1	±3%, ±5%	8	100	50	3.40	0.26	500
10	±3%, ±5%	8	100	50	3.20	0.26	500
12	±3%, ±5%	8	100	50	2.70	0.50	400
15	±3%, ±5%	8	100	50	2.30	0.50	400
18	±3%, ±5%	8	100	50	2.10	0.60	350
20	±3%, ±5%	8	100	50	2.00	0.60	350
22	±3%, ±5%	8	100	50	1.90	0.60	350
27	±3%, ±5%	8	100	50	1.60	0.70	300
33	±3%, ±5%	8	100	50	1.30	0.80	300
39	±3%, ±5%	8	100	50	1.20	1.00	250
43	±3%, ±5%	8	100	50	1.10	1.10	250
47	±3%, ±5%	8	100	50	1.00	1.10	250
56	±3%, ±5%	8	100	50	0.75	1.20	200
68	±3%, ±5%	8	100	50	0.75	1.40	200
82	±3%, ±5%	8	100	50	0.75	1.60	200
100	±3%, ±5%	8	100	50	0.70	2.00	200
120	±3%, ±5%	8	100	50	0.60	2.50	150
150	±3%, ±5%	8	100	50	0.55	3.00	150
180	±3%, ±5%	8	100	50	0.50	3.50	150
220	±3%, ±5%	8	100	50	0.45	3.70	100
270	±3%, ±5%	8	100	50	0.40	4.50	100
330	±3%, ±5%	6	50	50	0.35	5.00	80
360	±3%, ±5%	6	50	50	0.30	6.00	80

Operating temperature range: -55~+125°C

**Standard Electrical Specifications**

CL03-S Multilayer Chip Inductors / Standard Type

Inductance (nH)	Tolerance	Quality Factor /min.	Test Freq. (MHz)	Test Voltage (mV)	SRF (GHz) Min.	RDC (Ω) Max.	Rate Current (mA) Max.
1.0	±0.3nH	8	100	50	10.00	0.05	500
1.2	±0.3nH	8	100	50	10.00	0.05	500
1.5	±0.3nH	8	100	50	6.00	0.10	500
1.8	±0.3nH	8	100	50	6.00	0.10	500
2.0	±0.3nH	8	100	50	6.00	0.10	500
2.2	±0.3nH	8	100	50	6.00	0.10	500
2.4	±0.3nH	8	100	50	6.00	0.12	500
2.7	±0.3nH	10	100	50	6.00	0.12	500
3.3	±0.3nH	10	100	50	6.00	0.15	500
3.6	±0.3nH	10	100	50	6.00	0.16	500
3.9	±0.3nH	10	100	50	6.00	0.16	500
4.3	±0.3nH	10	100	50	6.00	0.18	500
4.7	±0.3nH	10	100	50	6.00	0.20	500
5.1	±0.3nH	10	100	50	5.50	0.25	500
5.6	±0.3nH	10	100	50	5.00	0.25	500
6.8	±5%, ±10%	10	100	50	5.00	0.30	500
7.5	±5%, ±10%	10	100	50	4.50	0.35	500
8.2	±5%, ±10%	10	100	50	4.50	0.35	500
9.1	±5%, ±10%	10	100	50	3.50	0.40	500
10	±5%, ±10%	12	100	50	3.50	0.40	300
12	±5%, ±10%	12	100	50	3.00	0.45	300
15	±5%, ±10%	12	100	50	2.30	0.50	300
18	±5%, ±10%	12	100	50	2.20	0.55	300
22	±5%, ±10%	12	100	50	2.00	0.60	300
24	±5%, ±10%	12	100	50	2.00	0.60	300
27	±5%, ±10%	12	100	50	1.70	0.65	300
33	±5%, ±10%	12	100	50	1.50	0.70	300
36	±5%, ±10%	12	100	50	1.40	0.70	300
39	±5%, ±10%	12	100	50	1.40	0.70	300
47	±5%, ±10%	12	100	50	1.20	0.70	300
56	±5%, ±10%	12	100	50	1.10	0.75	300
68	±5%, ±10%	12	100	50	0.90	0.85	300
82	±5%, ±10%	8	100	50	0.80	1.00	300
100	±5%, ±10%	8	100	50	0.70	1.20	300
120	±5%, ±10%	8	50	50	0.60	1.40	200
150	±5%, ±10%	8	50	50	0.50	1.60	200
180	±5%, ±10%	8	50	50	0.40	1.90	200
220	±5%, ±10%	8	50	50	0.35	2.40	200
270	±5%, ±10%	8	50	50	0.35	2.60	150
330	±5%, ±10%	8	50	50	0.35	2.80	150
390	±5%, ±10%	8	50	50	0.30	3.20	150
430	±5%, ±10%	8	50	50	0.28	3.40	150
470	±5%, ±10%	8	50	50	0.25	3.60	150
560	±3%, ±5%, ±10%	8	50	-	0.25	4.00	100
680	±3%, ±5%, ±10%	8	50	-	0.25	4.50	100

Operating temperature range: -40~+85°C

**High Q Electrical Specifications**

CL01-S Multilayer Chip Inductors / High Q Type

Inductance (nH)	Tolerance	Quality Factor /min.	Test Freq. (MHz)	Test Voltage (mV)	SRF (GHz) Min.	RDC (Ω) Max.	Rate Current (mA) Max.
0.6	±0.1nH, ±0.2nH, ±0.3nH	14	500	50	10000	0.05	1000
0.7	±0.1nH, ±0.2nH, ±0.3nH	14	500	50	10000	0.05	1000
0.8	±0.1nH, ±0.2nH, ±0.3nH	14	500	50	10000	0.06	1000
0.9	±0.1nH, ±0.2nH, ±0.3nH	14	500	50	10000	0.06	800
1.0	±0.1nH, ±0.2nH, ±0.3nH	14	500	50	10000	0.07	800
1.1	±0.1nH, ±0.2nH, ±0.3nH	14	500	50	10000	0.07	800
1.2	±0.1nH, ±0.2nH, ±0.3nH	14	500	50	10000	0.10	800
1.3	±0.1nH, ±0.2nH, ±0.3nH	14	500	50	10000	0.10	700
1.4	±0.1nH, ±0.2nH, ±0.3nH	14	500	50	10000	0.10	700
1.5	±0.1nH, ±0.2nH, ±0.3nH	14	500	50	10000	0.10	650
1.6	±0.1nH, ±0.2nH, ±0.3nH	14	500	50	10000	0.10	650
1.7	±0.1nH, ±0.2nH, ±0.3nH	14	500	50	10000	0.10	650
1.8	±0.1nH, ±0.2nH, ±0.3nH	14	500	50	9000	0.15	650
2.0	±0.1nH, ±0.2nH, ±0.3nH	14	500	50	8500	0.15	650
2.2	±0.1nH, ±0.2nH, ±0.3nH	14	500	50	7500	0.15	650
2.4	±0.1nH, ±0.2nH, ±0.3nH	14	500	50	7500	0.15	550
2.6	±0.1nH, ±0.2nH, ±0.3nH	14	500	50	7500	0.20	550
2.7	±0.1nH, ±0.2nH, ±0.3nH	14	500	50	7500	0.20	550
2.8	±0.1nH, ±0.2nH, ±0.3nH	14	500	50	7500	0.20	500
3.0	±0.1nH, ±0.2nH, ±0.3nH	14	500	50	7500	0.20	450
3.3	±0.1nH, ±0.2nH, ±0.3nH	14	500	50	7500	0.25	450
3.6	±0.1nH, ±0.2nH, ±0.3nH	14	500	50	6500	0.25	400
3.9	±0.1nH, ±0.2nH, ±0.3nH	14	500	50	6500	0.25	400
4.3	±0.1nH, ±0.2nH, ±0.3nH	14	500	50	6000	0.35	350
4.7	±0.1nH, ±0.2nH, ±0.3nH	14	500	50	6000	0.40	350
5.1	±0.1nH, ±0.2nH, ±0.3nH	14	500	50	5500	0.40	350
5.6	±0.1nH, ±0.2nH, ±0.3nH	14	500	50	5000	0.40	350
6.2	±0.1nH, ±0.2nH, ±0.3nH	14	500	50	5000	0.40	300
6.8	±3%, ±5%	14	500	50	4500	0.50	300
7.5	±3%, ±5%	14	500	50	4000	0.50	300
8.2	±3%, ±5%	14	500	50	4000	0.50	250
9.1	±3%, ±5%	14	500	50	4000	0.70	250
10	±3%, ±5%	14	500	50	4000	0.70	250
12	±3%, ±5%	13	500	50	3500	0.70	250
15	±3%, ±5%	13	500	50	3200	0.85	250
18	±3%, ±5%	13	500	50	3000	1.00	200
20	±3%, ±5%	13	500	50	2200	1.10	150
22	±3%, ±5%	13	500	50	2200	1.20	150
27	±3%, ±5%	13	500	50	2200	1.50	140
33	±3%, ±5%	12	300	50	1800	1.80	120
36	±3%, ±5%	12	300	50	1700	2.00	120
39	±3%, ±5%	12	300	50	1600	2.00	120
43	±3%, ±5%	12	300	50	1600	2.20	100
47	±3%, ±5%	12	300	50	1500	2.20	100
56	±3%, ±5%	12	300	50	1200	2.50	100
68	±3%, ±5%	12	300	50	1000	3.20	100
75	±3%, ±5%	11	300	50	1000	3.60	100
82	±3%, ±5%	11	300	50	1000	3.80	100
91	±3%, ±5%	11	300	50	900	3.80	80
100	±3%, ±5%	11	300	50	800	4.00	80
120	±3%, ±5%	10	300	50	800	5.00	80

Operating temperature range: -55~+125°C

**High Q Electrical Specifications**

CL02-S Multilayer Chip Inductors / High Q Type

Inductance (nH)	Tolerance	Quality Factor /min.	L/Q Freq. (MHz)	Q (Typical) Freq.(MHz)				SRF (GHz) Min.	RDC (Ω) Max.	IDC (mA) Max.
				100	250	900	1800			
1.0	±0.1nH, ±0.2nH, ±0.3nH	20	250	13	22	48	75	6.00	0.05	1000
1.2	±0.1nH, ±0.2nH, ±0.3nH	20	250	13	22	48	75	6.00	0.05	1000
1.5	±0.1nH, ±0.2nH, ±0.3nH	20	250	13	22	58	76	6.00	0.05	1000
1.8	±0.1nH, ±0.2nH, ±0.3nH	20	250	13	22	49	78	6.00	0.07	800
2.0	±0.1nH, ±0.2nH, ±0.3nH	20	250	14	23	49	82	6.00	0.07	800
2.2	±0.1nH, ±0.2nH, ±0.3nH	20	250	14	23	49	82	6.00	0.07	800
2.4	±0.1nH, ±0.2nH, ±0.3nH	20	250	14	23	47	78	6.00	0.07	800
2.5	±0.1nH, ±0.2nH, ±0.3nH	20	250	14	23	47	78	6.00	0.07	800
2.7	±0.1nH, ±0.2nH, ±0.3nH	20	250	14	23	48	82	6.00	0.09	700
2.9	±0.1nH, ±0.2nH, ±0.3nH	20	250	14	23	48	82	6.00	0.09	700
3.0	±0.1nH, ±0.2nH, ±0.3nH	20	250	14	23	50	84	6.00	0.09	700
3.3	±0.1nH, ±0.2nH, ±0.3nH	20	250	14	24	52	90	6.00	0.09	700
3.6	±0.1nH, ±0.2nH, ±0.3nH	20	250	15	24	55	95	6.00	0.10	700
3.9	±0.1nH, ±0.2nH, ±0.3nH	20	250	15	25	50	89	6.00	0.10	700
4.1	±0.1nH, ±0.2nH, ±0.3nH	20	250	15	25	49	86	6.00	0.12	650
4.3	±0.1nH, ±0.2nH, ±0.3nH	20	250	15	25	49	86	6.00	0.13	600
4.7	±0.1nH, ±0.2nH, ±0.3nH	20	250	15	26	50	88	6.00	0.13	600
5.1	±0.1nH, ±0.2nH, ±0.3nH	20	250	15	26	49	84	5.50	0.13	600
5.6	±0.1nH, ±0.2nH, ±0.3nH	20	250	15	27	50	84	5.50	0.13	600
5.8	±0.1nH, ±0.2nH, ±0.3nH	20	250	15	27	50	82	5.50	0.13	600
6.2	±0.1nH, ±0.2nH, ±0.3nH	20	250	15	27	50	80	5.50	0.14	550
6.8	±2%, ±3%, ±5%	22	250	15	27	55	89	5.00	0.15	550
7.3	±2%, ±3%, ±5%	22	250	15	27	54	90	5.00	0.16	550
7.5	±2%, ±3%, ±5%	22	250	15	27	54	90	5.00	0.16	550
8.2	±2%, ±3%, ±5%	22	250	15	27	56	84	5.00	0.16	550
8.7	±2%, ±3%, ±5%	22	250	15	27	53	80	5.00	0.17	500
9.1	±2%, ±3%, ±5%	22	250	15	27	53	79	4.50	0.18	500
9.5	±2%, ±3%, ±5%	22	250	15	27	52	77	4.50	0.18	500
10	±2%, ±3%, ±5%	22	250	16	29	52	75	4.50	0.18	500
11	±2%, ±3%, ±5%	22	250	16	28	52	71	4.00	0.20	500
12	±2%, ±3%, ±5%	22	250	16	29	51	68	4.00	0.20	500
15	±2%, ±3%, ±5%	22	250	16	29	50	60	4.00	0.22	430

Operating temperature range: -55~+125°C

**High Frequency Electrical Specifications**

CL02-S Multilayer Chip Inductors / High Frequency Type

Inductance (nH)	Tolerance	Quality Factor /min.	L/Q Freq. (MHz)	Q(Typical) Freq.(MHz)						SRF min. (GHz)	RDC (Ω) max.	IDC (mA) max.
				100	300	500	800	1000	1800			
1.0	±0.3nH	5	100	9	16	20	25	28	31	>8.50	0.10	500
1.2	±0.3nH	5	100	9	15	18	24	27	31	>8.50	0.12	500
1.5	±0.3nH	5	100	7	12	16	20	21	29	>8.50	0.15	500
1.8	±0.3nH	5	100	7	12	16	20	21	29	>8.50	0.17	500
2.2	±0.3nH	5	100	7	12	16	20	21	30	>8.50	0.17	500
2.7	±0.3nH	5	100	7	12	16	20	21	29	>8.50	0.20	500
3.3	±0.3nH	5	100	7	12	15	19	20	27	>8.50	0.22	400
3.9	±0.3nH	5	100	7	12	15	20	21	28	7.50	0.25	400
4.7	±0.3nH	5	100	7	12	15	19	20	27	6.50	0.28	400
5.6	±0.3nH	5	100	8	12	15	20	22	30	6.50	0.30	400
6.8	±5%, ±10%	5	100	8	12	15	20	22	30	6.50	0.35	400
8.2	±5%, ±10%	5	100	8	12	15	19	21	30	6.50	0.38	350
10	±5%, ±10%	5	100	8	13	16	21	23	32	4.70	0.42	350
12	±5%, ±10%	5	100	8	13	16	20	23	27	4.30	0.47	350
15	±5%, ±10%	5	100	8	12	15	19	22	28	4.00	0.50	300
18	±5%, ±10%	5	100	8	13	16	21	24	32	4.00	0.60	250
22	±5%, ±10%	5	100	8	13	17	22	26	31	3.50	0.70	200
27	±5%, ±10%	5	100	8	14	18	23	26	32	3.00	0.80	200
33	±5%, ±10%	5	100	8	14	17	23	27	32	2.50	0.90	200
39	±5%, ±10%	5	100	8	14	18	23	27	32	2.00	1.00	200
47	±5%, ±10%	7	100	9	14	18	22	24	29	2.40	2.20	100
56	±5%, ±10%	7	100	9	14	18	23	24	29	2.30	2.50	100
68	±5%, ±10%	7	100	9	14	17	22	24	29	2.20	2.70	100
82	±5%, ±10%	7	100	8	13	17	20	20	16	2.10	2.90	100
100	±5%, ±10%	7	100	8	13	17	20	20	13	2.00	3.20	100

Operating temperature range: -55~+125°C

CL03-S Multilayer Chip Inductors / High Frequency Type

Inductance (nH)	Tolerance	Quality Factor /min.	L/Q Freq. (MHz)	Q(Typical) Freq.(MHz)						SRF min. (GHz)	RDC (Ω) max.	IDC (mA) max.
				100	300	500	800	1000	1800			
10	±5%	8	100	10	22	28	35	39	45	>6.00	0.6	500
12	±5%	8	100	10	18	23	26	32	42	6.00	0.7	500
15	±5%	8	100	12	22	28	35	39	42	5.50	0.8	500
18	±5%	8	100	10	18	22	25	30	43	5.20	0.9	300
22	±5%	8	100	12	21	27	34	37	37	5.00	1.0	300
27	±5%	8	100	10	18	24	26	32	38	4.80	1.2	300
33	±5%	8	100	12	21	27	33	35	31	4.50	1.4	300
39	±5%	8	100	11	20	26	32	34	29	4.00	1.5	200
47	±5%	8	100	12	20	26	31	34	27	3.50	1.6	200
56	±5%	8	100	11	20	26	31	34	24	3.00	1.8	200
68	±5%	8	100	10	18	21	24	28	20	2.80	2.0	200
82	±5%	8	100	10	19	22	26	26	15	2.50	2.2	200
100	±5%	8	100	10	19	24	27	25	-	2.00	2.5	150
120	±5%	8	100	10	19	23	26	24	-	1.60	2.8	150
150	±5%	8	100	10	18	24	26	23	-	1.40	3.0	150
180	±5%	8	100	10	17	22	23	-	-	1.00	3.4	150

Operating temperature range: -40~+85°C

**Environmental Characteristics**

Electrical Performance Test

Item	Requirement	Test Condition
Inductance	In Within specified tolerance	Temperature: 20±1°C Relative Humidity: 45 to 85%RH Atmospheric Pressure: 86 to 106kpa Measuring equipment and fixture: 0201: E4991A+HP16197A 0402/0603: E4991A+HP16192A Test Signal: -20dBm or 50mV Test compensation(for 0201 high Q): Product true value= test value + compensation value. for L<3.6nH, compensation value is 0.25nH; for 3.6nH≤L<6.8nH, compensation value is 0.43nH; for 6.8 nH≤L<9.1nH, compensation value is 0.5nH; for 9.1 nH≤L<33nH, compensation value is 0.85nH; for L≥33 nH compensation value is 0.85nH
Q Value	In accordance with electrical specification	Temperature: 20±1°C Relative Humidity: 45 to 85%RH Atmospheric Pressure: 86 to 106kpa
DC Resistance	In accordance with electrical specification	Temperature: 20±1°C Relative Humidity: 45 to 85%RH Atmospheric Pressure: 86 to 106kpa Measuring equipment: HP 4338

Mechanical Characteristics Test

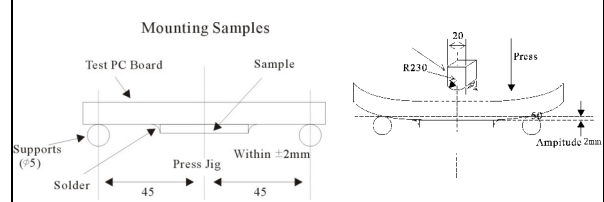
Item	Requirement	Test Condition
Bending Strength	No mechanical damage shall be observed	Flexure: 2mm Pressurizing speed: 0.5mm/sec Keep time: 30sec 
Solderability	No visible mechanical damage Wetting shall exceed 75% coverage for 0201 series; exceed 95% coverage for others	Solder temperature: 240±2°C Time: 3 seconds Solder: Sn/3.0Ag/0.5Cu Flux: 25% resin and 75% ethanol in weight
Resistance to Soldering Heat	No visible mechanical damage Wetting shall exceed 75% coverage for 0201 series; exceed 95% coverage for others Inductance change: within±10% Q change: within±20%	Solder temperature: 260±3°C Time: 5 seconds Solder: Sn/3.0Ag/0.5Cu Flux: 25% resin and 75% ethanol in weight The chip shall be stabilized at normal condition for 1~2 hours before measuring
Dropping	No visible mechanical damage Inductance change: within±10% Q change: within±20%	Drop chip inductor 10 times on a concrete floor form a height of 100cm



Climatic Test

Item	Requirements	Test Condition
Thermal Shock		0201/0402 series: -55°C for 30±3 min→125°C for 30±3 min 0603 series: -40°C for 30±3 min→85°C for 30±3 min Transforming interval: max. 20 seconds Test cycle: 100 cycles The chip shall be stabilized at normal condition for 1~2 hours Before measuring
Resistance to Low Temperature		Temperature: 0201/0402 series: -55±2°C ; 0603 series: -40±2°C Time: 1000±24 hours The chip shall be stabilized at normal condition for 1~2 hours Before measuring
Resistance to High Temperature	No visible damage	Temperature: 0201/0402 series: 125±2°C ; 0603 series: 85±2°C Time: 1000±24 hours The chip shall be stabilized at normal condition for 1~2 hours Before measuring
Damp Heat (Steady States)	Inductance variation within 10% Q variation within 20%	Temperature: 60±2°C Humidity: 90~95% RH. Time: 1000±24 hours The chip shall be stabilized at normal condition for 1~2 hours Before measuring
Loading Under Damp Heat		Temperature: 60±2°C Humidity: 90~95% RH. Time: 1000±24 hours Applied current: Rated current The chip shall be stabilized at normal condition for 1~2 hours Before measuring
Loading at High Temperature (Life Test)		Temperature: 0201/0402 series: 125±2°C ; 0603 series: 85±2°C Time: 1000±24 hours Applied current: Rated current The chip shall be stabilized at normal condition for 1~2 hours Before measuring

■ Storage Temperature: 15~28°C; Humidity < 80%RH

■ Packaging Specifications

Reel Dimension

Unit: mm

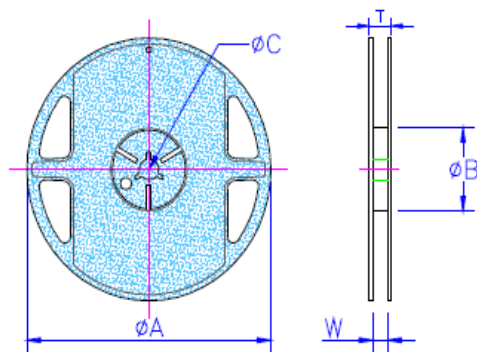

Type	A	B	C	W	T	Quantity (EA)
CL01-S	178±1	60.0±0.5	13.0±0.20	9.00±0.5	12.0±0.15	15,000
CL02-S	178±2.0	57.0±2.0	12.5±1.5	8.00+1.5/-0	12.0±0.15	10,000
CL03-S	178±1	60.0±0.5	13.0±0.20	9.00±0.5	12.0±0.15	4,000

Tape Specifications

Unit: mm

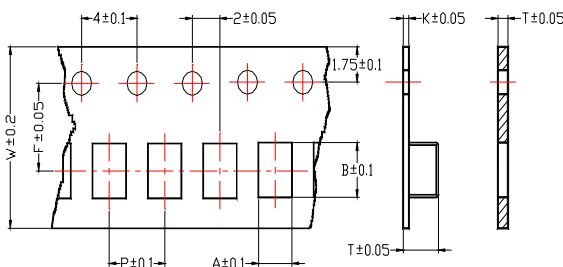

Type	A	B	T	W	P	F	K	Tape
CL01-S	0.40	0.70	0.50	8	2	3.5	-	B
CL02-S	0.65	1.15	0.60	8	2	3.5	-	B
CL03-S	1.10	1.80	1.10	8	4	3.5	-	B

Type A Type B