

ELECTRICAL SPECIFICATIONS	
TYPE	HC-49US/SMD
Part Number	AS49SSD-3.579545M-FE300F2
Nominal frequency	3.579545 MHz
Oscillation mode	Fundamental
Frequency tolerance	± 30 ppm 25±3°C
Temperature characteristics	± 50 ppm
Operating Temperature	-10°C~+70°C
Storage Temperature	-40°C~+125°C
Load capacitance	30.0 pF
Drive level	100 μW
Series capacitance (C ₁)	— fF
Parallel capacitance (C ₀)	7.0 pF Max
Series resistance	150 Ω Max
Aging	± 5 ppm Max /Year

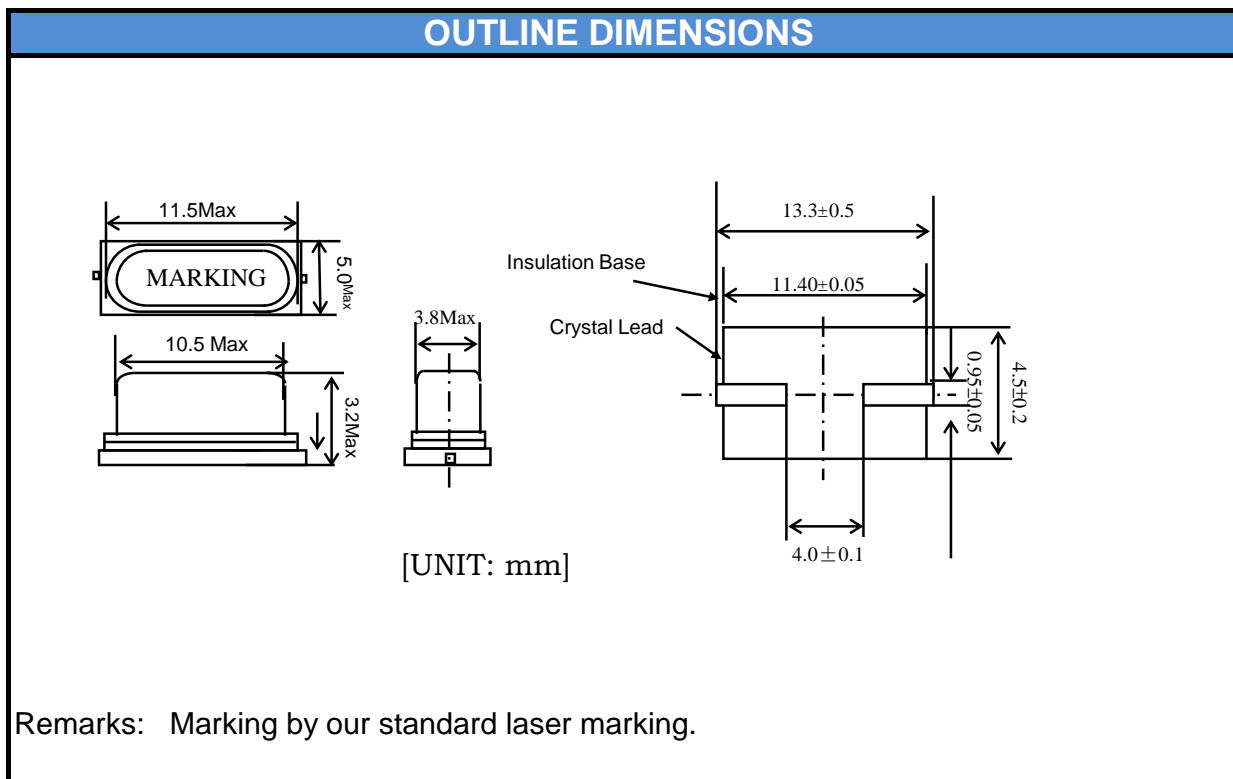

* Specification subject to change without prior notice.