

**SWISSDIS**



Swissdis AG  
Grasweg 7  
CH-4911 Schwarzhäusern

Tel.: +41 62 919 44 00  
Fax: +41 62 919 44 01  
[info@swissdis.ch](mailto:info@swissdis.ch)  
[www.swissdis.ch](http://www.swissdis.ch)



# SPECIFICATIONS

LED SMD PLCC2 White

**UP3528W-DS**

Version March 2015

# Unilite Opto Technology

*email: info@unilite-tech.com*

## U-P3528W-DS-EL-A



### ■ Description

The PLCC2 type U-P3528W-DS-EL-A TOP VIEW LED, with its light weight , enables smaller board size, higher packing density, reduced storage space and miniature applications.

- Dice Material : InGaN
- Light Color : White
- Lens Color : Yellow phosphor

### ■ Features

- 1 chips package
- Compatible with automatic placement equipment
- Compatible with reflow soldering process
- Long operating life
- Low forward voltage operated
- Instant light
- Pb -free/ RoHS compliant
- 3000 pcs / Reel

### ■ Applications

- Information boards
- Automotive Interior Lighting
- Indoor and outdoor display
- Indicator
- Backlighting
- Light bar
- General applications

# Unilite Opto Technology

email: [info@unilite-tech.com](mailto:info@unilite-tech.com)

## U-P3528W-DS-EL-A

### ■ Outline Dimensions ( mm )

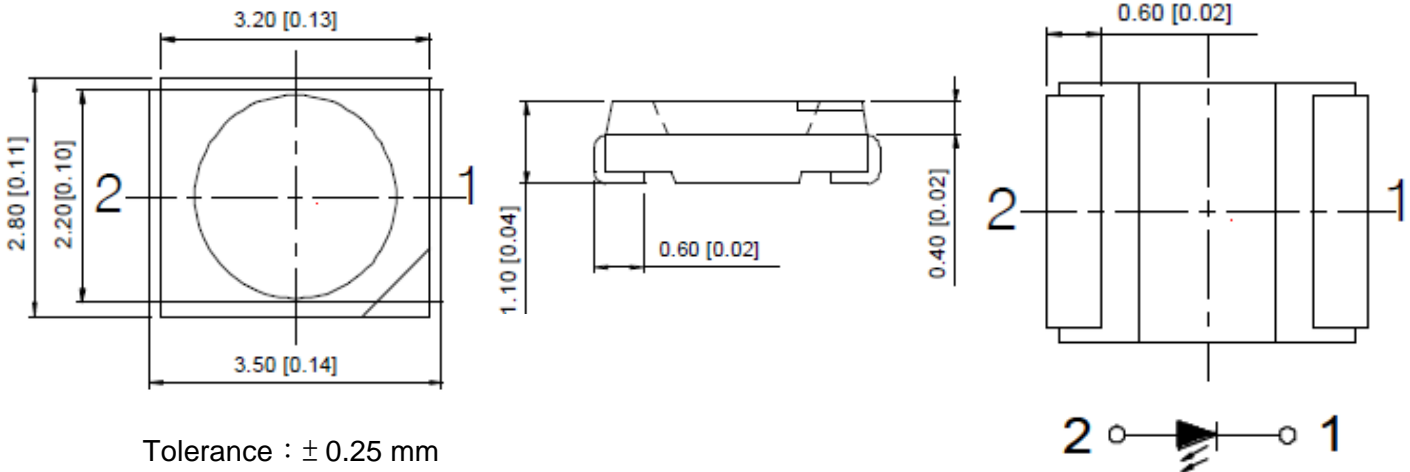

### ■ Recommended Soldering Pad Design

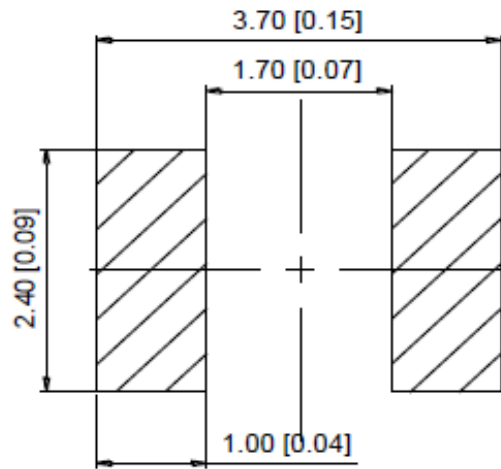

UNIT:mm

### ■ Part Numbering System

**U - P 3 5 2 8 W - DS - EL - A**

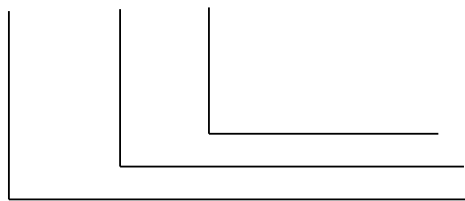

Color code  
Package code  
Product code

# Unilite Opto Technology

email: [info@unilite-tech.com](mailto:info@unilite-tech.com)

## U-P3528W-DS-EL-A

### ■ Absolute Maximum Ratings at $T_a = 25\text{ }^\circ\text{C}$

PARAMETER	symbol	MAX.	UNIT
Power Dissipation *	PD	100	mW
Continuous Forward Current *	IF	30	mA
Peak Forward Current ( 1/10 Duty Cycle , 0.1ms Pulse Width ) *	IFP	100	mA
Reverse Voltage	VR	5	V
Operating Temperature Range	Topr	-30 to + 100	$^\circ\text{C}$
Storage Temperature Range	Tstg	-40 to + 100	$^\circ\text{C}$
Reflow Soldering Condition	Tsld	260 $^\circ\text{C}$ for 10 sec. 2 time.	

### ■ Electro-Optical Characteristics

Condition :  $I_F = 20\text{mA}$  ,  $T_a = 25^\circ\text{C}$

PARAMETER	SYMBOL	TEST CONDITION	VALUES			UNIT
			MIN.	TYP.	MAX.	
* Forward Voltage	$V_F$	$I_F=20\text{mA}$		3.3	3.6	V
Reverse Current	$I_R$	$V_R= 5\text{V}$			10	$\mu\text{A}$
Viewing Angle at 50% $I_v$	$2\theta$ 1/2	$I_F=20\text{mA}$		120		Deg.

# Unilite Opto Technology

email: [info@unilite-tech.com](mailto:info@unilite-tech.com)

## U-P3528W-DS-EL-A

■ Bin Grade Limits ( $I_F = 20 \text{ mA}^*$ ) Luminous Intensity / mcd Tolerance :  $\pm 15\%$

Item		Min	Max	Unit
Luminous Intensity	W1	1070	1210	mcd
	W2	1210	1360	mcd
	W3	1360	1520	mcd
	W4	1520	1690	mcd
	W5	1690	1870	mcd
	W6	1870	2070	mcd
	W7	2070	2200	mcd
	W8	2200	2400	mcd
	W9	2400	2700	mcd

■ Bin Grade Limits ( $I_F = 20 \text{ mA}$ ) Forward Voltage / v

Bin Code	Min	Max	Unit
V16	1.6	1.8	V
V18	1.8	2.0	V
V20	2.0	2.2	V
V22	2.2	2.4	V
V24	2.4	2.6	V
V26	2.6	2.8	V
V28	2.8	3.0	V
V30	3.0	3.2	V
V32	3.2	3.4	V
V33	3.4	3.6	V
V34	3.6	3.8	V

# Unilite Opto Technology

email: [info@unilite-tech.com](mailto:info@unilite-tech.com)

## U-P3528W-DS-EL-A

■ Bin Grade color temperature Ta=25C

Bin	Color Kelvin	1		2		3		4	
		X	Y	X	Y	X	Y	X	Y
WEM1	2670-2850K	0.4705	0.4508	0.4866	0.4542	0.4767	0.4366	0.4614	0.4333
WEM2		0.4614	0.4333	0.4767	0.4366	0.4671	0.4196	0.4525	0.4126
WEM3		0.4525	0.4126	0.4671	0.4196	0.4577	0.4029	0.4436	0.3991
WEM4		0.4436	0.3991	0.4577	0.4029	0.4490	0.3875	0.4356	0.3837
WEN1	2850-3050K	0.4538	0.4460	0.4705	0.4508	0.4614	0.4333	0.4456	0.4287
WEN2		0.4456	0.4287	0.4614	0.4333	0.4525	0.4162	0.4376	0.4116
WEN3		0.4376	0.4116	0.4525	0.4162	0.4436	0.3991	0.4294	0.3943
WEN4		0.4294	0.3943	0.4436	0.3991	0.4356	0.3837	0.4221	0.3970
WEP1	3050-3250K	0.4312	0.4234	0.4385	0.4040	0.4538	0.4460	0.4456	0.4287
WEP2		0.4240	0.4065	0.4312	0.4234	0.4456	0.4287	0.4376	0.4116
WEP3		0.4165	0.3890	0.4240	0.4065	0.4376	0.4116	0.4294	0.3943
WEP4		0.4165	0.3890	0.4294	0.3943	0.4221	0.3790	0.4100	0.3738
WEQ1	3250-3500K	0.4312	0.4234	0.4148	0.4161	0.4209	0.4326	0.4385	0.4405
WEQ2		0.4240	0.4065	0.4086	0.3955	0.4148	0.4161	0.4312	0.4234
WEQ3		0.4165	0.3890	0.4021	0.3822	0.4086	0.3995	0.4240	0.4065
WEQ4		0.4165	0.3890	0.4100	0.3738	0.3966	0.3673	0.4021	0.3822
WER1	3500-3800K	0.4023	0.4220	0.4209	0.4326	0.4148	0.4161	0.3963	0.4035
WER2		0.3963	0.4035	0.4148	0.4161	0.4086	0.3955	0.3924	0.3909
WER3		0.3924	0.3909	0.4086	0.3995	0.4021	0.3822	0.3871	0.3739
WER4		0.3871	0.3739	0.4021	0.3822	0.3966	0.3673	0.3826	0.3595
WES1	3800-4100K	0.3811	0.3937	0.3860	0.4130	0.4023	0.4228	0.3963	0.4035
WES2		0.3783	0.3825	0.3811	0.3937	0.3963	0.4035	0.3924	0.3909
WES3		0.3741	0.3658	0.3783	0.3825	0.3924	0.3909	0.3871	0.3739
WES4		0.3741	0.3658	0.3871	0.3739	0.3826	0.3595	0.3706	0.3520
WET1	4100-4500K	0.3811	0.3937	0.3642	0.3829	0.3673	0.4003	0.3860	0.4130
WET2		0.3783	0.3825	0.3622	0.3716	0.3642	0.3829	0.3811	0.3937
WET3		0.3741	0.3658	0.3594	0.3557	0.3622	0.3716	0.3783	0.3825
WET4		0.3741	0.3658	0.3706	0.3520	0.3571	0.3426	0.3594	0.3557
WEU1	4500-5000K	0.3481	0.3856	0.3673	0.4003	0.3642	0.3829	0.3469	0.3717
WEU2		0.3469	0.3717	0.3642	0.3829	0.3622	0.3716	0.3458	0.3592
WEU3		0.3458	0.3592	0.3622	0.3716	0.3594	0.3557	0.3444	0.3442
WEU4		0.3444	0.3442	0.3594	0.3557	0.3571	0.3426	0.3434	0.3320
WEV1	5000-5650K	0.3286	0.3690	0.3481	0.3856	0.3469	0.3717	0.3288	0.3102
WEV2		0.3288	0.3569	0.3469	0.3717	0.3458	0.3592	0.3290	0.3569
WEV3		0.3290	0.3451	0.3458	0.3592	0.3444	0.3442	0.3292	0.3451
WEV4		0.3292	0.3313	0.3444	0.3442	0.3434	0.3320	0.3294	0.3313
WEW1	5650-6300K	0.3136	0.3550	0.3286	0.3690	0.3288	0.3569	0.3148	0.3444
WEW2		0.3148	0.3444	0.3288	0.3569	0.3290	0.3451	0.3160	0.3332
WEW3		0.3160	0.3332	0.3290	0.3451	0.3292	0.3313	0.3175	0.3204
WEW4		0.3292	0.3313	0.3294	0.3202	0.3186	0.3102	0.3175	0.3204
WEW5		0.3294	0.3202	0.3295	0.3105	0.3469	0.3013	0.3186	0.3102
WEX1	6300-7000K	0.3031	0.3327	0.3011	0.3422	0.3136	0.3555	0.3148	0.3444
WEX2		0.3052	0.3224	0.3031	0.3327	0.3148	0.3444	0.3160	0.3332
WEX3		0.3076	0.3108	0.3052	0.3224	0.3160	0.3332	0.3175	0.3204
WEX4		0.3196	0.3013	0.3112	0.2932	0.3076	0.3108	0.3175	0.3204

# Unilite Opto Technology

email: [info@unilite-tech.com](mailto:info@unilite-tech.com)

## U-P3528W-DS-EL-A

### ■ White Color Binning of CCT

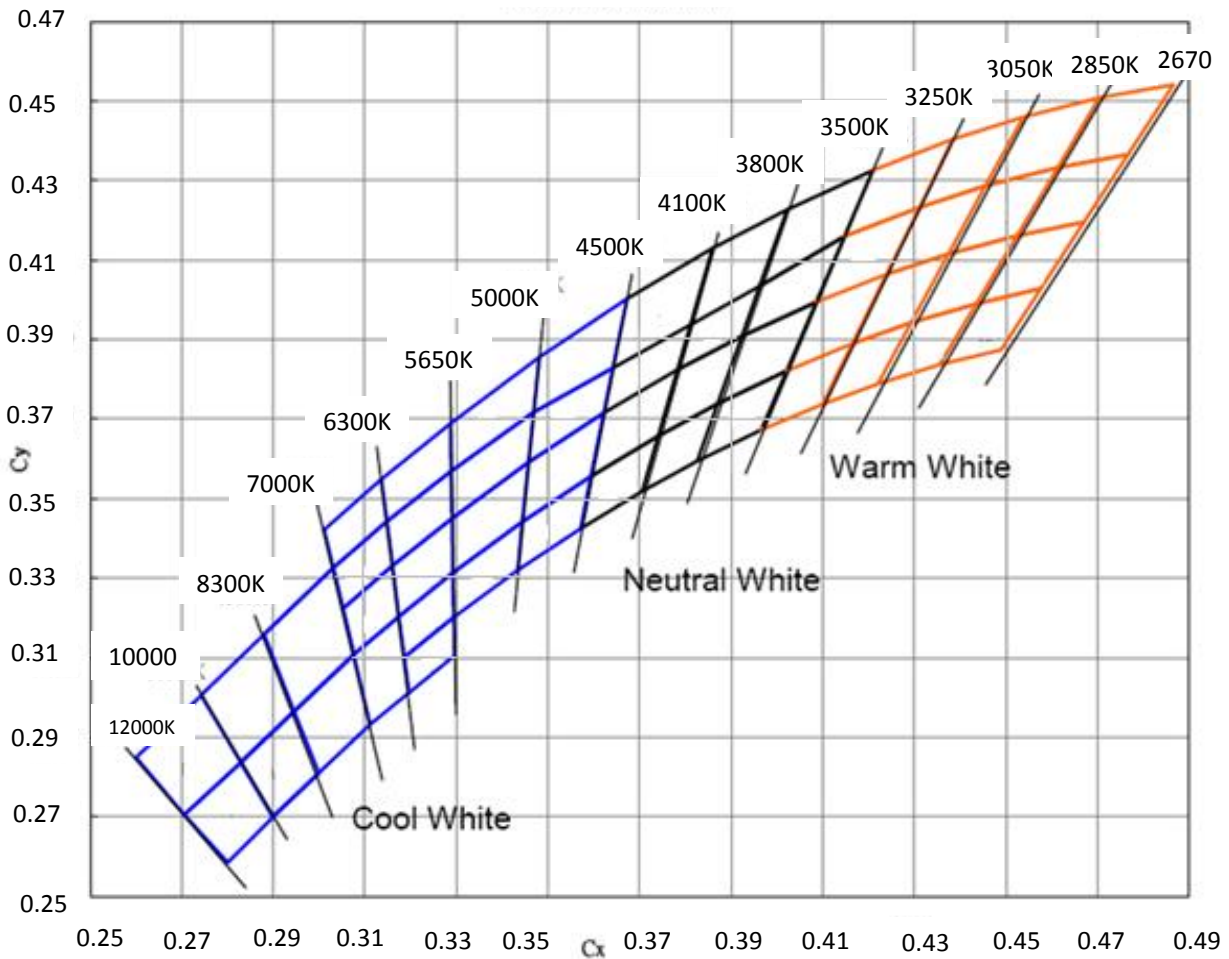

# Unilite Opto Technology

email: [info@unilite-tech.com](mailto:info@unilite-tech.com)

## U-P3528W-DS-EL-A

### ■ Typical Electrical/Optical Characteristic curve

Volt-Ampere Characteristics

Relative Luminous Intensity VS Forward

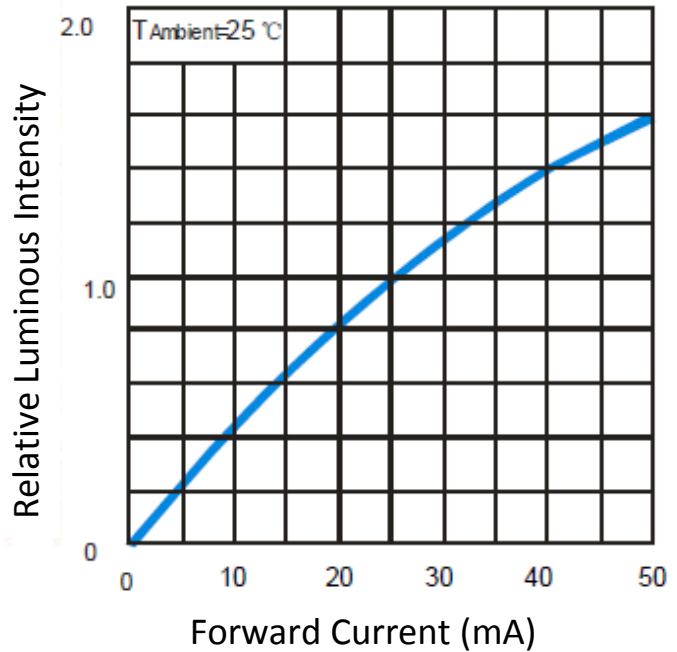
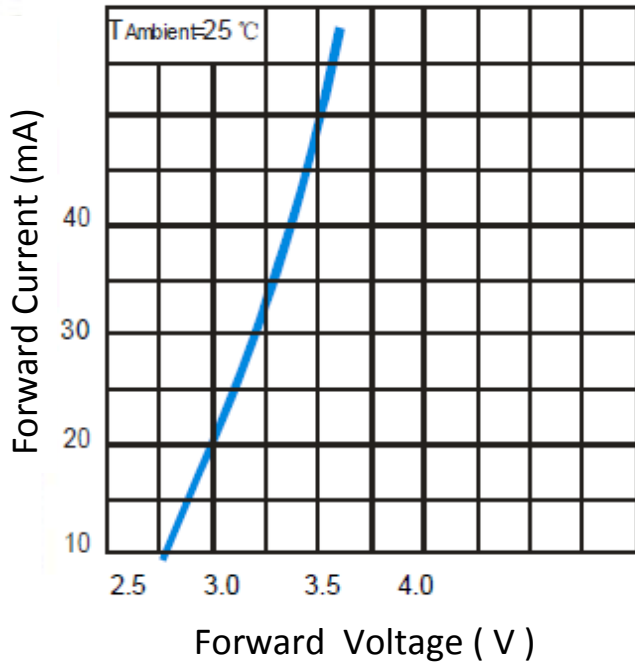

Forward Current Derating

Luminous Intensity VS Ambient

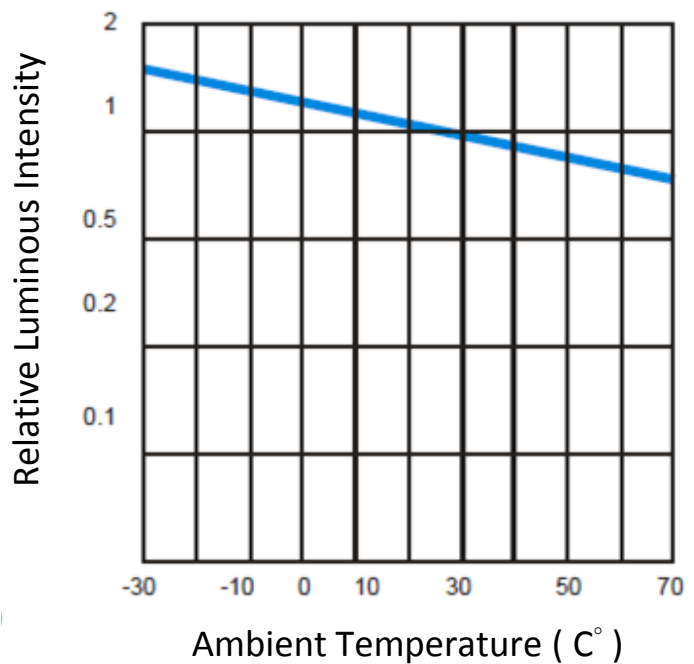
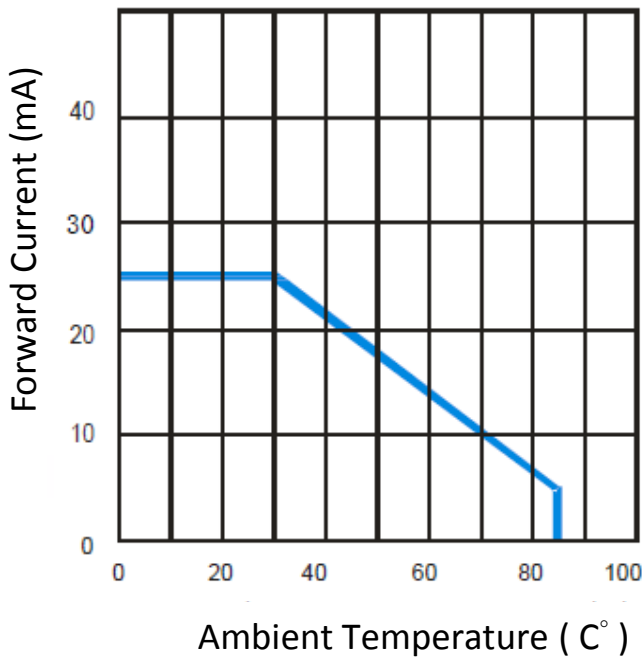



# Unilite Opto Technology

email: [info@unilite-tech.com](mailto:info@unilite-tech.com)

**U-P3528W-DS-EL-A**

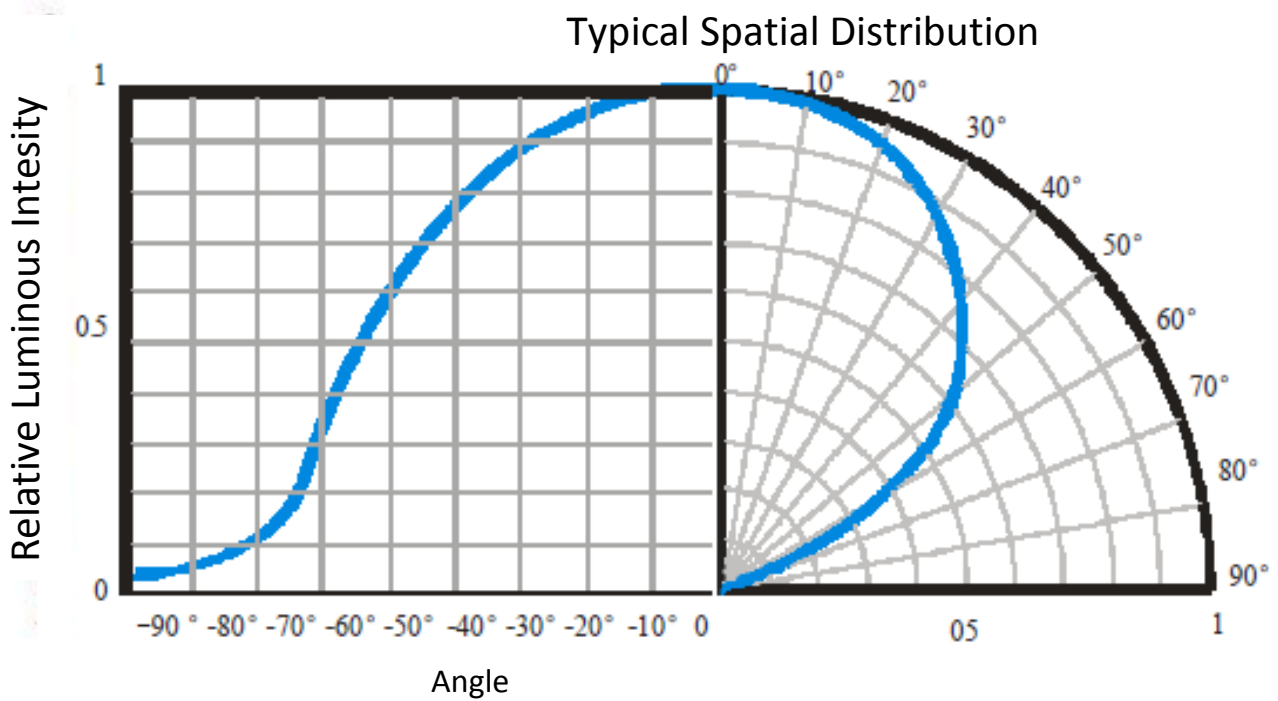
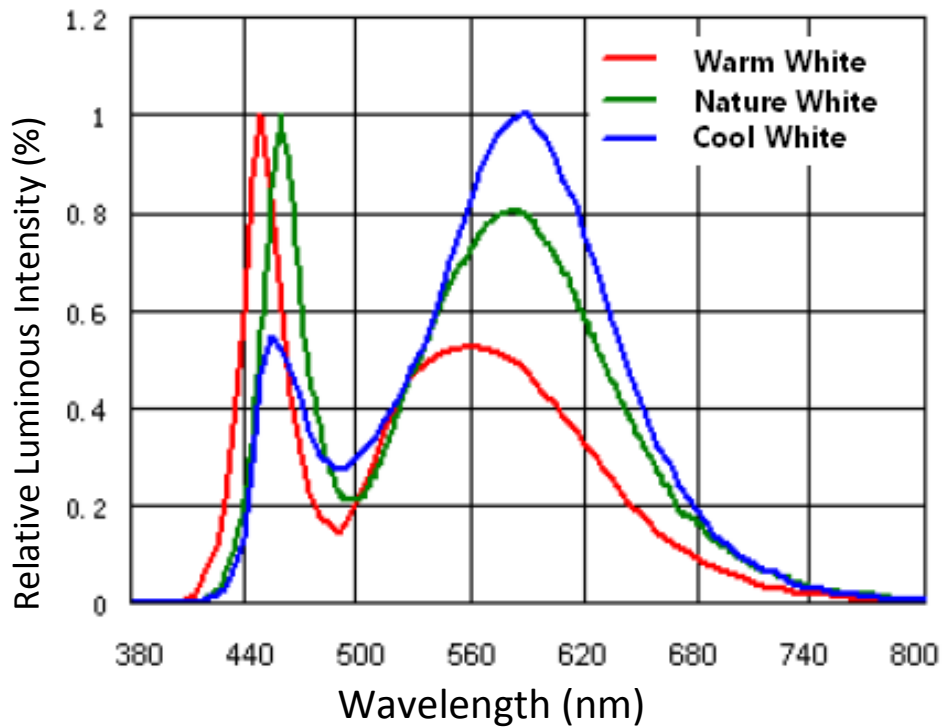

# Unilite Opto Technology

email: [info@unilite-tech.com](mailto:info@unilite-tech.com)

## U-P3528W-DS-EL-A

### ■ Carrier Type Dimension

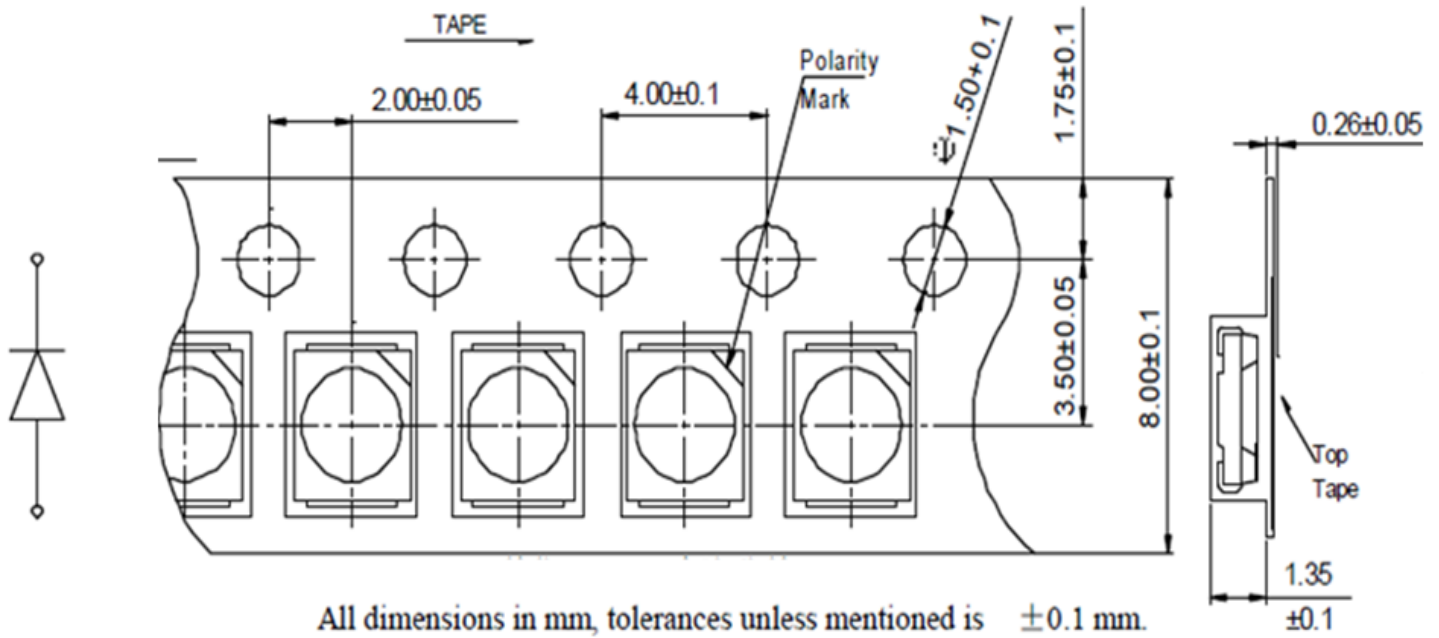

Units : mm

### ■ Reel Dimension

3000 pcs / Reel

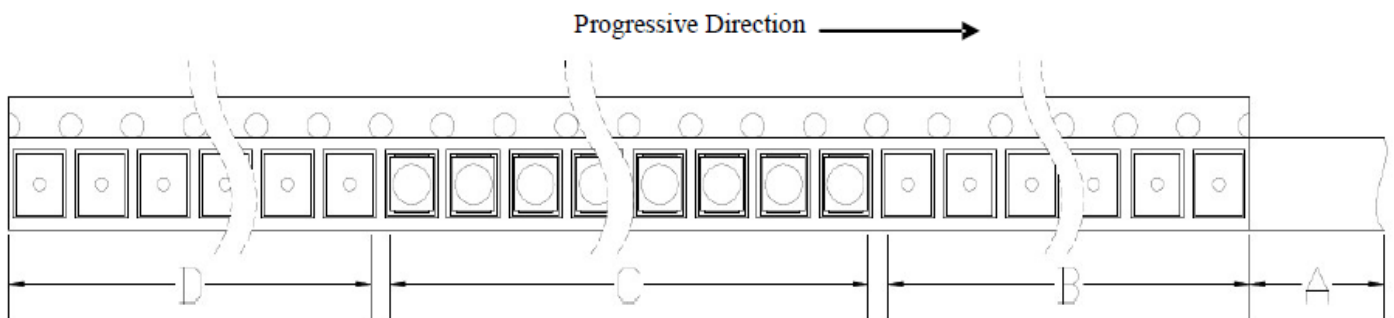

A: Top Cover Tape, 300mm; B: Leader, Empty, 200mm; C: 3000 Lamps Loaded; D: Trailer, Empty, 200mm.

# Unilite Opto Technology

email: [info@unilite-tech.com](mailto:info@unilite-tech.com)

## U-P3528W

### ■ Reliability Test Items and Conditions

#### (1) TEST ITEMS AND RESULTS

Test Item	Standard Test Method	Test Conditions	Note	Number of Damaged
Resistance to Soldering Heat (Reflow Soldering)	JEITA ED-4701 300 301	Tsd=260°C , 10secs	2 times	0/60
Thermal Shock	—	-40°C ~ 100°C 30min. 30min.	100 cycles	0/60
Temperature Cycle	JEITA ED-4701 100 105	-40°C ~ 25°C ~ 100°C ~ 25°C 30min. 5min. 30min. 5min.	100 cycles	0/60
High Temperature Storage	JEITA ED-4701 200 201	Ta=100°C	1000 hrs.	0/60
Low Temperature Storage	JEITA ED-4701 200 202	Ta=-40°C	1000 hrs.	0/60
Steady State Operating Life	—	Ta=25°C, I <sub>F</sub> =30mA, DC	1000 hrs.	0/60
Steady State Operating Life of High Temperature	—	Ta=85°C, I <sub>F</sub> =25mA, DC	1000 hrs.	0/60
Steady State Operating Life of High Humidity Heat	—	60°C, RH=90%, I <sub>F</sub> =20mA, DC	1000 hrs.	0/60

#### (2) CRITERIA FOR JUDGING DAMAGE

Item	Symbol	Test Conditions	Criteria for Judgement
Forward Voltage	V <sub>F</sub>	I <sub>F</sub> =20mA	Δ % < 10%
Reverse Current	I <sub>R</sub>	V <sub>R</sub> =5V	Δ % < 30%
Luminous Intensity	I <sub>V</sub>	I <sub>F</sub> =20mA	< 10μA

# Unilite Opto Technology

*email: info@unilite-tech.com*

## U-P3528W-DS-EL-A

### ■ Cautions

#### (1) Moisture Proof Package

- A) The moisture proof package, a plastic bag with a zipper, is used to keep moisture to a minimum in the package.
- B) A package of a moisture absorbent material (silica gel) is also inserted into the plastic moisture proof bag and the silica gel changes its color from blue to pink as it absorbs moisture.
- C) The absorbed moisture in the SMT package may vaporize and expand during soldering. This may cause exfoliation of the contacts and damage to the optical characteristics of the LEDs.

#### (2) Storage Conditions

- A) Before opening the package :  
The LEDs should be kept at 30°C or less and 45~60% RH or less and should be used within a year. When storing the LEDs, moisture proof package with absorbent material (silica gel) is recommended.
- B) After opening the package :  
The LEDs should be kept at 30°C or less and 55% RH or less and should be soldered within 168 hours (7days) after opening the package. The unused LEDs should be stored in moisture proof packages.
- C) It's also recommended to return the LEDs to the original moisture proof bag and to reseal the moisture proof bag again.
- D) If the moisture absorbent material (silica gel) has faded away or the SMD LEDs have exceeded the storage time, baking treatment ( more than 24 hours at 65+/-5°C ) should be performed before soldering.

#### (3) Heat Generation

- A) The thermal design of the end product is very important. It is necessary to avoid intense heat generation and operate within the maximum ratings given in this specification.
- B) The operating current should be decided after considering the ambient maximum temperature of LEDs.

#### (4) Cleaning

- A) Isopropyl alcohol is recommended to be used as a solvent for cleaning the LEDs.
- B) Before cleaning, a pre-test should be done to confirm whether any damage to the LEDs will occur.

# Unilite Opto Technology

email: [info@unilite-tech.com](mailto:info@unilite-tech.com)

## U-P3528W-DS-EL-A

### (5) Soldering

Reflow Soldering ( recommended ) :

- A) To prevent from cracking, please bake ( 65°C , 24hrs ) before soldering.
- B) When soldering, do not load stress on the LEDs during heating.
- C) Never take next process until the component is cooled down to room temperature after reflow.
- D) After soldering, do not warp the circuit board.
- E) The recommended reflow soldering profile ( measuring on the surface of the LED resin ) is the following:

#### (a) Lead-Free Solder

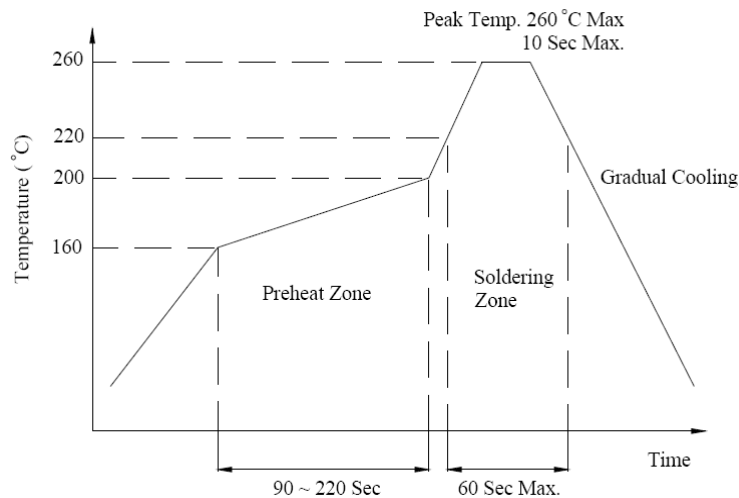

#### (b) Lead Solder

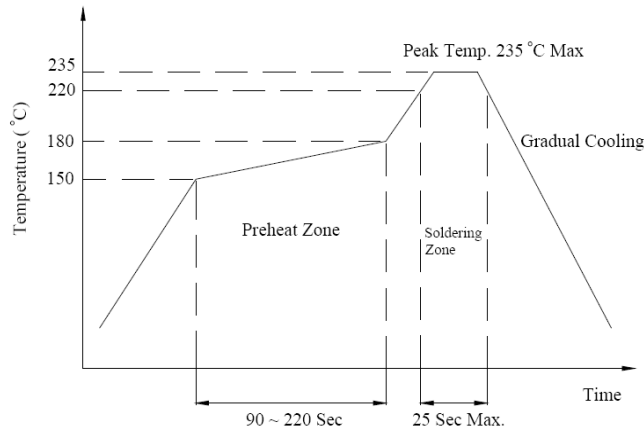

Manual Soldering ( not recommended ) :

- A) To prevent from cracking, please bake ( 65°C , 24hrs ) before soldering.
- B) Temperature at tip of iron: 250°C Max. ( 25W ).
- C) It's banned to load any stress on the resin during soldering.
- D) Soldering time: 3 sec. Max.( one time only ).

# Unilite Opto Technology

*email: info@unilite-tech.com*

## U-P3528W-DS-EL-A

- (6) ESD ( electrostatic discharge ) protection ( base on machine mode )
- A) The product is Gallium Nitride ( GaN ) based light emitting diode ( LED ) and is extremely sensitive to ESD. Users are strongly recommended to take necessary meter to test the static electricity and avoid ESD when handling this product.
  - B) Proper grounding of machines ( via  $1M\Omega$  ), using static dissipative mats, containers, working uniforms and shoes are considered to be effective against ESD.
  - C) An ionizer is recommended in the facility or environment where ESD may be generated easily, and soldering iron with a grounded tip is also recommended.
  - D) When inspecting the final products in which LEDs are assembled, it is recommended to check whether the assembled LEDs are damaged by ESD or not. It is simple to find damaged LEDs by light-on or VF test at lower current ( below 1mA is recommended ).
  - E) ESD damaged LEDs will show some unusual characteristics such as the remarkable increasing of leak current, the decreasing of forward voltage, or the LEDs do not light on at the low current.
- (7) Other
- A) Care must be taken to ensure that the reverse voltage will not exceed the absolute maximum rating when using the LEDs with matrix drive.
  - B) The LED light output is strong enough to injure human eyes. Precaution must be taken to prevent looking directly at the LEDs with unaided eyes for more than a few seconds.
  - C) The LEDs described here are intended to be used for ordinary electronic equipment, please consult Unilite Opto in advance for information on applications.
  - D) Installing a protection device in the LED driving circuit to avoid surge current exceeding the max rating during on/off switching.
  - E) The appearance and specifications of the product may be modified for improvement without notice.
  - F) Please use the product within 168 hours after opening the seal and keep under 30 °C and 70% humidity.
  - G) Unilite Opto Technology will not be responsible for any claim for damage if the user use the product without following the caution or instruction of the specification.